

MOUNTING THE ROSETTE

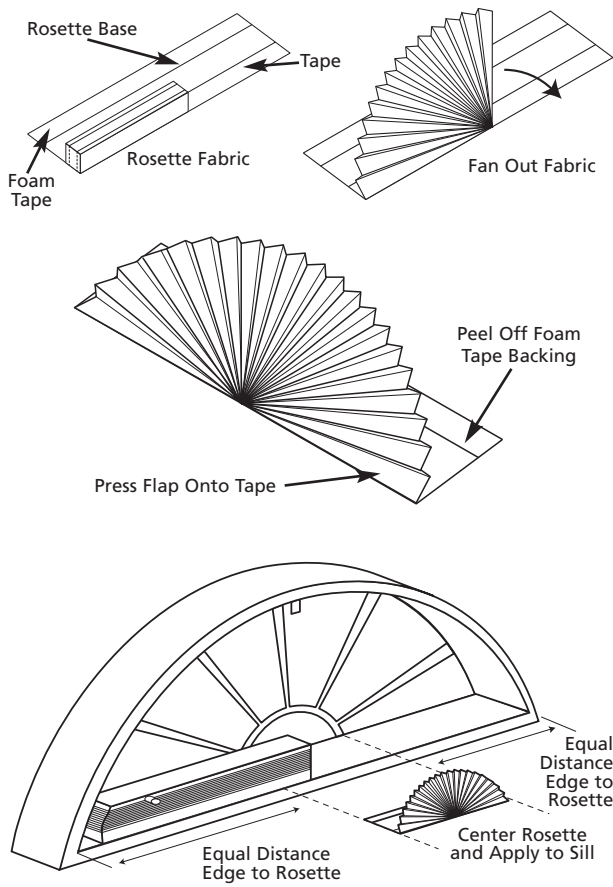

The rosette is sent in a closed stack. Peel off the release liner from the tape on the top front of the rosette base. Fan out the fabric and press the fabric onto the tape as shown.

Peel off the release liner from the foam tape on the back bottom of the rosette base and attach the rosette to the sill as shown. The rosette should be centered in the window opening.

CLEANING AND CARE

The shade fabric is easy to care for. Regular dusting with a feather duster or vacuum cleaner brush is recommended. Most stains can be blotted with a damp sponge and mild detergent. For problem stains, the shade can be removed from the mounting brackets and soaked in warm water. When damp, raise shade tightly to re-crisp pleats. Before using anything stronger than mild detergent and lukewarm water, test an unobtrusive corner of the shade. If you have any questions, call your dealer for advice.

KENSINGTON

WINDOW EXPRESSIONS™

PLEATED FAN STYLE ARCH SHADE

INSTALLATION INSTRUCTIONS

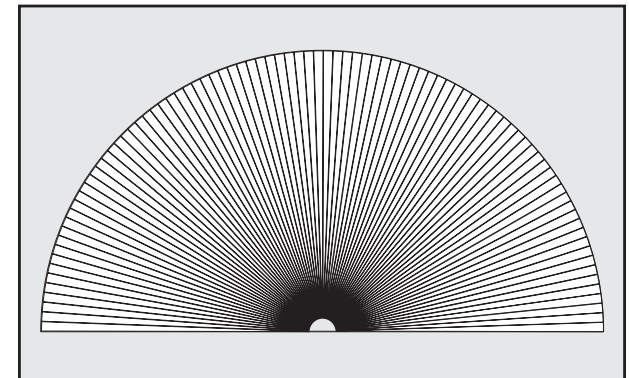

Manufactured By

K KENSINGTON
WINDOW EXPRESSIONS™
Art for windows™

STATIONARY FAN STYLE ARCH

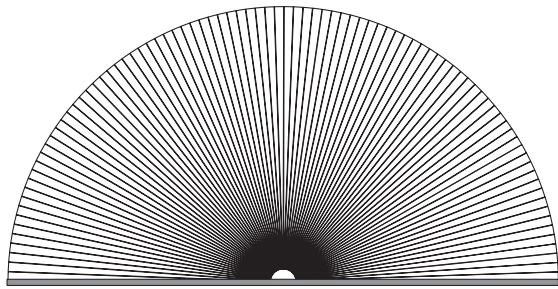

Remove end caps from the rail. Slide the fabric stack into the middle of the bottom rail. Fan the fabric out and slide the free stiffened fabric into the rail. Use care when sliding fabric into the rail so that you don't tear the fabric on the corners of the rail. Slide the stiffened cells into the rail so that the ends of the stiffener match up with the ends of the bottom rail. Inside the center of the rail, mark where the stiffened fabric ends. Peel the paper liner off the piece of plastic stiffener provided and adhere to the inside of the bottom of the rail. Replace end caps and insert rail into installation brackets.

TO MOUNT INSTALLATION BRACKETS

1. Catch front groove of rail with front groove of bracket.
2. Center rail in opening.
3. Push the rail back and down to catch back of rail in bracket (A). Then release (B).

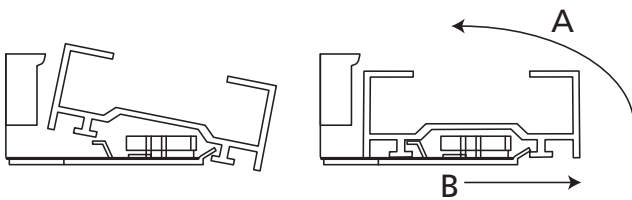

Unwind the cord from the shade but keep the rubber bands around the shade stack.

1. Hold the shade down near the brackets and insert the front clip on the bracket into the front groove of the rail.
2. Make sure the shade is centered in the window opening.
3. Push the rail back and down until the back clips of the brackets are inserted in the back groove of the rail. Then release the front pressure to allow the back clips to engage.

To remove the shade, reverse the procedure.

Place an attachment hook at the top center of the arch and others evenly spaced down each side. Using a needle or awl, make a hole on the crease line of the white back cell at the position of each attachment hook. Hang fabric on attachment hook.

SIDE MOUNT BRACKET INSTALLATION

1. Line up the bracket top with the desired height of the top of the headrail.
2. Mark holes for screws. Brackets must be level. Remove brackets and drill holes.
3. Insert bugle head screws for keyhole slots only. Approximately 1/8" of the screw should be left protruding.

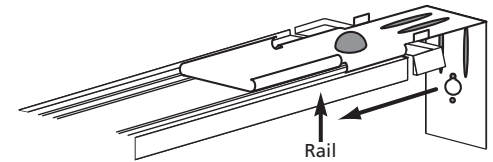
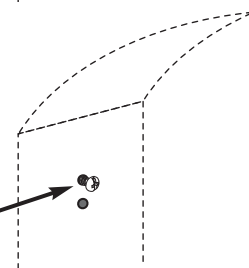
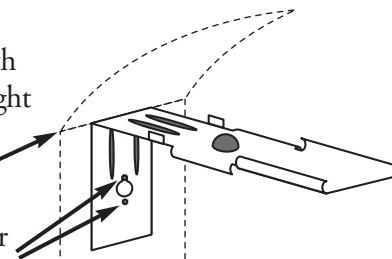

4. Pull the cord lock assembly partially out of the headrail and slide the bracket on as shown. Push the cord lock assembly and bracket back all the way into the rail.
5. Remove the endcap from the opposite end of the headrail. Slide the remaining side mount bracket on the headrail. Replace the end cap before sliding the bracket all the way into the headrail.
6. Hook one bracket onto the screw in the window frame, using the keyhole slot. Bring the other end bracket over the screw at the other side of the frame. Slide down, flexing bracket inward until the screw engages in the keyhole slot.
7. Make sure both brackets are slipped down all the way in the keyhole slot so that the screw is in the top portion of the keyhole slot. Install a screw in the bottom hole of each bracket. Tighten all screws.