

## EQUALIZATION ADJUSTMENT

After installation, the shade may shift to one side as it rolls up, and require adjustment at the bottom rail. Flip the bottom rail up so you can see the bottom of the rail. If the fabric is moving to the right (or the right side of the bottom rail is higher than the left), turn the left side screw clockwise. If the fabric is moving to the left (or the left side of the bottom rail is higher than the right), turn the right side screw clockwise.

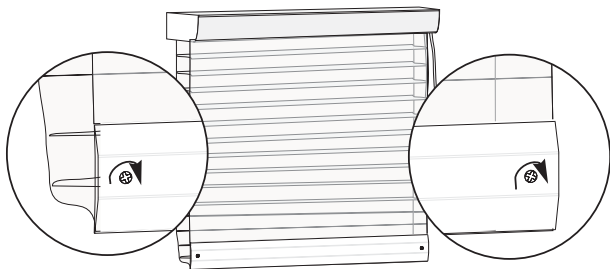

## CHILD SAFETY

The Consumer Product Safety Commission requires the use of a cord tie down (cord tensioner) on all continuous loop cord systems. The use of such a device is intended to significantly reduce the occurrence of infant or small child strangulation injuries or deaths resulting from the looped pull cords on various window treatment products.

The Cord Tensioner is installed on the Lift Cord before packaging. The Tensioning device should be mounted in the proper position to pull the cord taut in order to reduce the possibility of injury.

## CORD TENSIONER INSTALLATION

Lower the shading. Choose one of the three installation methods shown to position the tension device on the window frame or the wall so that the tension device and the control cord do not interfere with shade operation.

The control cord must be taut but still operable. Do not allow for any slack. Do not twist or cross the control cord.

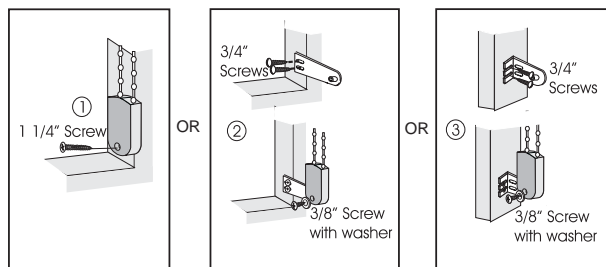

## OPERATION

Pulling down on the back cord will lower the shading. When the window shading is completely lowered, pulling down on the back cord will open the vanes. Continued pulling in this direction will raise the fabric with the vanes in the open position. **The window shading must only be raised a maximum of 24" in this manner to avoid damaging the fabric. There is no stop on the polyester cord option. DO NOT reverse roll more than 24".**

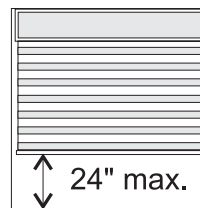

Pulling down on the front cord will close the vanes and then raise the shading.

## HOLD DOWN INSTALLATION (OPTIONAL)

Use the pin on the hold down bracket to punch out the front hole on the bottom rail end cap.

Mount the hold down to the side or back of the window frame so that the pin lines up with the front hole in the bottom rail end cap with the shade fully lowered and fully open.

Lower the shading and flex the hold down bracket outward so that the pin can be inserted into the hole in the end cap.

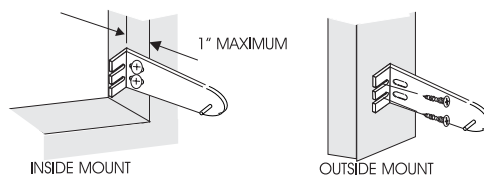

## CLEANING AND CARE

The soft and delicate feel of Horizontal Window Shadings belies the durability of the material. Horizontal Window Shadings are made of sturdy, knitted polyester fabrics and may be feather dusted or vacuumed at a low suction setting. Spots or stains can be rubbed clean with a damp sponge and mild soap. To avoid discoloration of the material, we recommend against the use of chemical cleaners. If necessary the shading may be ultrasonically cleaned by a professional.

All knitted fabrics experience weave variations due to heat, humidity and other room conditions. These variations can result in slight bowing, puckering and dimpling of the Sheer material. The possible variations are minor and have been shown through case study not to detract from the beauty of this product.

Manufactured By  **KENSINGTON**  
WINDOW EXPRESSIONS™  
*Art for windows™*

# KENSINGTON

WINDOW EXPRESSIONS™

## HORIZONTAL WINDOW SHADINGS

## INSTALLATION INSTRUCTIONS

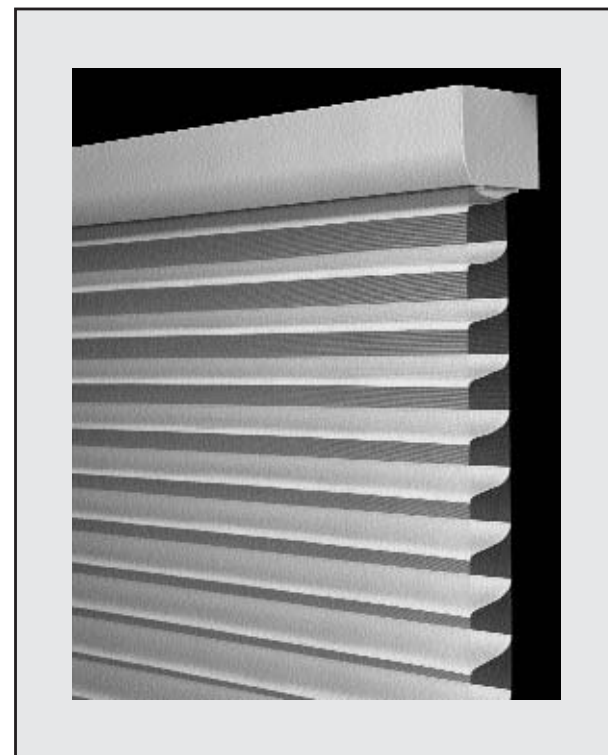

## BASICS

A few simple tools are required:

- Measuring tape
- Carpenters Level
- Power drill or Phillips head Screwdriver
- Hex head and/or Phillips driver bit

Additional fasteners other than those sent with your shading may be required depending on the mounting surface. Wallboard and plaster require the use of anchors such as expansion or toggle bolts. Brick, tile or stone need special plugs and drill bits. Remember to always pre-drill holes in wood to avoid splitting.

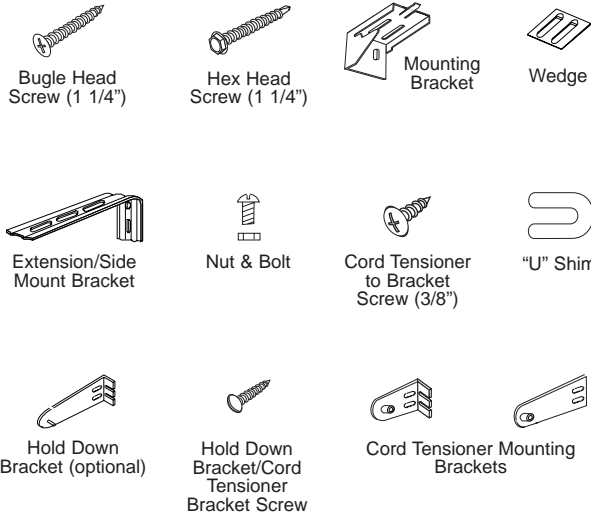

## BRACKET INSTALLATION

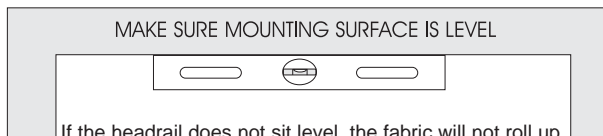

If the headrail does not sit level, the fabric will not roll up evenly which could damage the edges of the shading fabric. Use shims if necessary to level brackets.

End brackets should be located with centerlines 2" in from each end. Depending on the width of the shading, additional brackets may be necessary evenly spaced between the two end brackets.

For Shade widths of:	Use this # of Brackets
Up to 40"	2
>40" - 72"	3
>72" - 84"	4
>84" - 114"	5

## INSIDE MOUNT

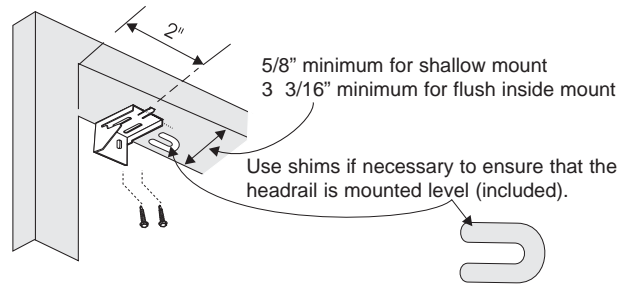

## FULLY RECESSED INSIDE MOUNT

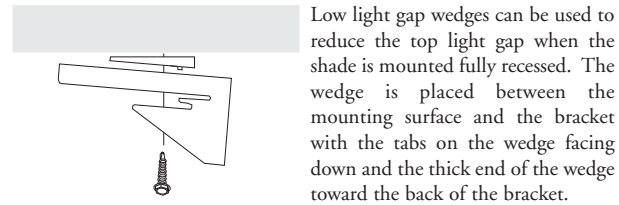

## OUTSIDE MOUNT

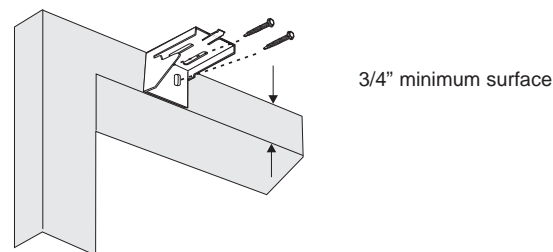

## EXTENSION BRACKET (OPTIONAL)

Optional Extension Brackets are used to project the back of the shading up to 2 1/2" from the mounting surface. Attach the Standard Mounting Bracket to the Extension Bracket with the nut and bolt provided.

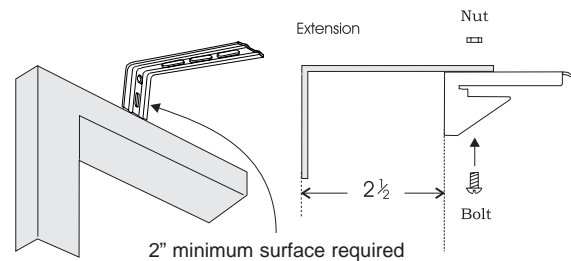

## SIDE MOUNT (OPTIONAL)

Measure from window sill up to desired mounting position on each side of the window frame. Mark position. Mount Side Mount Brackets on each side of window frame as shown. Make sure to confirm that headrail will sit perfectly level. Once Side Mount Brackets are installed and properly positioned, attach the Standard Mounting Brackets using the nuts and bolts provided.

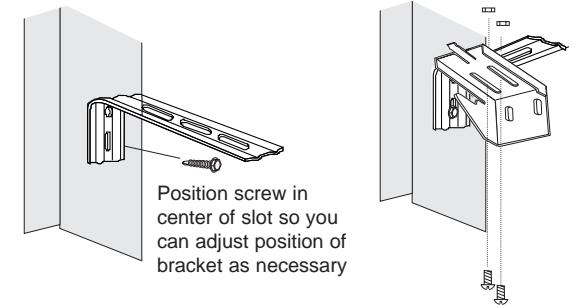

## HANGING THE SHADE

### BUMP STOPS

Before installing the shading, it is important to check the position of the bump stops inside the headrail. There are two stops which prevent the bottom rail from travelling too far into the headrail. These bump stops need to be at the ends of the headrail, butting up to the endcap. This will prevent the bottom rail from stacking unevenly in the headrail.

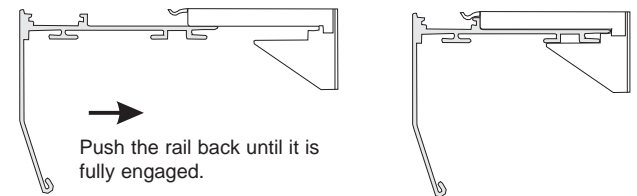
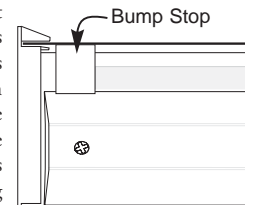

### INSTALL HEADRAIL

To remove the shading, partially lower the shading and insert a flat head screwdriver as shown (fig.10). Twist the screwdriver until the headrail disengages from the bracket.

